

# SETTING COMPRESSION PACKINGS



packings for valves and pumps





## **Carrara, high technology packings**

Carrara is among the leading manufacturers of packing and sealing systems for pumps and valves for all industrial applications. Thanks to the use of high quality yarns and special techniques developed by its R&D division, Carrara packings can offer high performance with an excellent quality-price ratio.

## **Not only packings, but also sealing systems**

Carrara sealing systems guarantee excellent sealing and emission control and can work at high pressures and speeds with any chemicals, reducing wear on shafts and bushings, and minimising maintenance.

## **Value added performance**

- Excellent sealing
- Emission control
- Resistant to high temperatures and speeds
- Low shaft and bushing wear
- Reduced maintenance

<b>0.0</b>	<b>Company</b>	Global Sealing Solutions
<b>1.0</b>	<b>Graphite Packings</b>	Packings and Valve sets Low Emission Services Steam Services Oxygen Services Graphite packings for Dynamic and General services
<b>2.0</b>	<b>Synthetic PTFE Packings</b>	Packings for centrifugal pumps Packings for piston pumps Packings for static and valve applications
<b>3.0</b>	<b>Packings for special applications</b>	Packings for glass tempering machines Packings for tank lid Packings for drawing machines
<b>4.0</b>	<b>Packing guide</b>	Technical data Range - Performer - Premium - Basic Packaging conditions Packing installation guide

**Disclaimer:** The technical information provided is based on the many years of experience that CARRARA S.p.A. has gained in sealing systems. Due to the wide variety of industrial applications and operating conditions, the conditions of use of the product described above cannot be extended to every application. Therefore, the data provided cannot be used to support complaints. CARRARA S.p.A declines any liability for damage to things or persons caused by improper use of its products and reserves the right to change this technical data sheet without prior notice.

# Carrara

Carrara Global Sealing Solutions, committed to Partnership

## 4 Operational Divisions

- Sealing systems and valve components
- Industrial Sealing Systems
- Environmental Services
- Technical yarns for industry

Carrara is a partner to the main manufacturers of fluid process control components and is qualified by both the main international EPCs and the main oil and gas players as a supplier of sealing systems and environmental services.

- 20,000 m<sup>2</sup> of covered area
- 160 employees
- Patented products
- Frame Agreements with International Customers





## Mission

- Satisfy our customers with efficient sealing systems.
- Provide our customers with the best technical and logistics solutions at the best price.
- Be committed to establishing long-term business relationships with our customers and collaborating with them to pursue continuous improvement.

## Assets

To pursue its mission, Carrara Global Sealing Solutions has equipped itself with the logistics spaces, equipment, management software and human resources needed for an increasingly competitive and demanding market.

- The large surface area of the plant allows a very rational flow of raw materials, semi-finished products and goods, ensuring the highest efficiency.
- The handling, machining, quality control and packaging equipment is all built into a process that can manage high product volumes while ensuring that they are traceable and meet the quality standards and delivery terms agreed with the customer.
- The use of SAP and advanced project management software minimises manual data processing to guarantee its integrity in every stage of the process.
- To ensure continuous improvement, human resource skills are continuously verified and updated within a structured plan.



## Sealing Solutions

Carrara offers sealing solutions to maximize performance, reduce shaft and bush wear, and thereby reduce the need for maintenance. Safety, efficiency and added value are the guidelines that drive the R&D department to choose materials and start manufacturing new products and upgrades.

## Partnership

### **Carrara Global Sealing Solutions, a Partner to win together!**

Carrara works with its customers in a globalised and competitive market to win together with them. That is why it offers skills and reliability in the modern role of supply chain partner.



# Graphite packings

## Valve Packings and Sets



# GR8622

## GR8622 API 622 APPROVED

GR8622 is an API 622 3rd Edition certified low emission packing for first-use seals and maintenance of industrial valves. It keeps its elastic properties and sealing performance over time without the need for re-tightening.



### Temperature

GR8622 can be used equally in cryogenics at -200°C and at very high temperatures up to 650°C with non-oxidising fluids and up to 450°C with weakly oxidising fluids and hot air.



### Pressure range

In order to work under any pressure condition\*, GR8622 was designed with specially reinforced expanded mineral graphite yarns, impregnated with the latest generation lubricant and passive corrosion inhibitor.



### Ph Range

GR8622 can be used with the whole range from 0 to 14, with the exception of strong oxidants.

\*Suitable for pressure classes up to API 10000.

## Approvals

- API 622 3rd Edition
- Fire Test API 589
- Corrosion Test
- Weight Loss Test EN 14772, section 6.7



# GR8622

## Design Low Emission



GR8622 is a graphite packing designed to minimize valve emissions. It can be used both as a first-use seal in the FULL PACKING configuration composed of 5 rings, and for the subsequent industrial valve maintenance needed to maintain the Low Emission certification.

## Applications

GR8622 was designed for VOC and VHAP fluids and most non-oxidising chemicals, but it can also be used for H.P./H.T. steam valves. With GR8622, you can manage the maintenance of all the valves in the plant with a single packing, thereby reducing warehouse costs and potential packing choice errors.





## PGT3 GR8622

### STEM PACKING

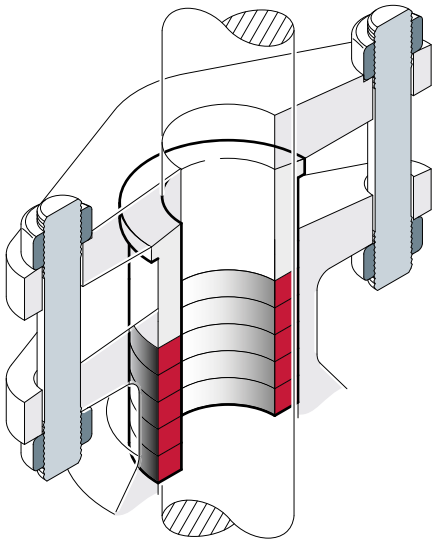
PGT3 GR8622 is a certified low emission stem packing, which guarantees a low friction coefficient and very low weight loss, ensuring very high service performance over extended periods.



-  **Temperature**  
-200°C to 650°C, with a limit of 450°C for weakly oxidising fluids and hot air.
-  **Pressure range**  
It covers all the pressure classes up to API 10000 psi.
-  **pH Range**  
0 to 14, except for strong oxidants.

### Approvals

- API 622 3rd Edition
- Fire Test API 589
- Corrosion Test
- Weight Loss Test EN 14772, section 6.7



**PGT3 GR8622**

### Full packing set

**PGT3 GR8622** is a set of seals made entirely from GR8622 packing. It complies with the requirements of 622 3rd Edition and can maintain certification continuity even during the subsequent valve maintenance phase, when it is inserted into the LDAR verification program.

### Applications

**PGT3 GR8622** is a set of graphite seals specifically for oil & gas and chemical applications, even with sour gasses with high H<sub>2</sub>S concentrations.



# PGT4 GR8622

## STEM PACKING

PGT4 GR8622 is a stem seal with low emission certification in accordance with the API and ISO standards. It is a valid solution for reducing the number of first-use seal types on new valves. In fact, it is equally suitable for use in oil & gas and chemical applications as well as for high pressure and temperature steam services.

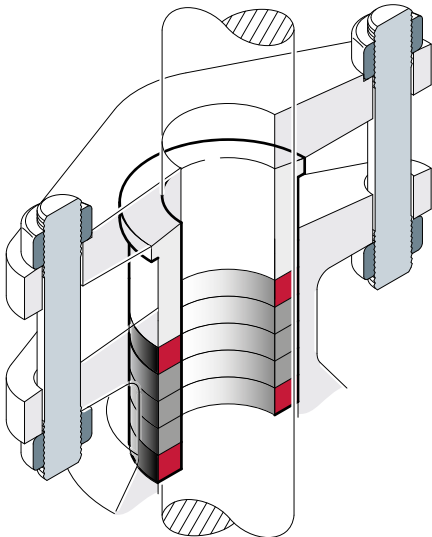

### Temperature

-200°C to 650°C, with a limit of 450°C for weakly oxidising fluids and hot air.



### Pressure range

It covers all the pressure classes up to API 10000 psi.



### pH Range

0 to 14, except for strong oxidants.

## Approvals

- ISO 15848 C01 BH
- ISO 15848 C02 BH
- API 622 3rd Edition
- Fire Test API 589
- Corrosion Test
- Weight Loss Test EN 14772, section 6.7



# PGT4 GR8622

## Full low emission approvals



PGT4 GR8622 is a set of seals with low emission approval in accordance with the API 622 3rd Edition and ISO 15848 (400°C, BH sealing class, C01 and C02 endurance class) standards, offering the greatest certification coverage with a single seal.

## Applications

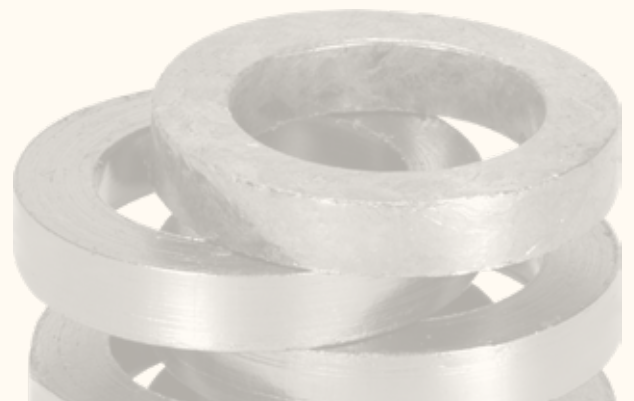

PGT4 GR8622 is a set of graphite seals for gate, globe, check and ball valves for oil & gas and chemical service. They can also be used with all industrial fluids that are compatible with graphite, so a single seal can be used in all applications.



## ■ GR80SGR

### TA LUFT VDI 2440 Approved

This is a valve packing made from very pure expanded graphite yarn with a special nickel alloy reinforcement. It is suitable for all uses that are compatible with graphite. Its special composition ensures excellent resistance to high pressures and temperatures with low weight losses, guaranteeing low emission levels.

- 
**Temperature**  
 -200°C to 650°C, with a limit of 450°C for weakly oxidising fluids and hot air.
- 
**Pressure range**  
 It covers all the pressure classes up to API 10000 psi.
- 
**pH Range**  
 0 to 14, except for strong oxidants.

- ### Approvals
- TA LUFT VDI 2440
  - Weight Loss Test EN 14772, section 6.7

**GR80SGR**



## GR80SGR, the TA LUFT packing

### Elastic, resistant and simple to install

Elasticity, wear resistance, ease of installation, low emission, extrusion resistance, low oxidation rate, low friction coefficient, non-corrosive. **GR80SGR** was designed and made to achieve all of these goals!

### Low oxidation rate and friction coefficient

**GR80SGR** is made from very pure materials, ensuring a low weight loss at high temperatures. Thanks to the special thread-by-thread impregnation with corrosion inhibitors and solid lubricants, **GR80SGR** keeps stems intact and reduces the need for re-tightening during service.

### Low Emission

**GR80SGR** is a packing that meets the requirements of TA LUFT VDI2440, thanks to its elasticity and low permeability.

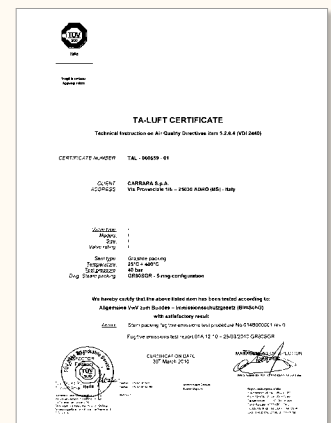

# ■ CONTROLLER ONE EVOLUTION

# ■ CONTROLLER 2 EVOLUTION

## CONTROLLER EVOLUTION.

The CONTROLLER EVOLUTION family of seals sets was designed and made to meet the demand for reliable products that comply with TA LUFT low emission requirements.

## CONTROLLER ONE EVOLUTION

It is a set of "Cup & Cone" seals with differential density rings specifically for valves that are subject to frequent motion, but it can be used in any application.

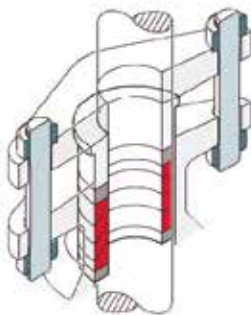

## CONTROLLER 2 EVOLUTION

This set of seals has square cross-section rings with a controlled density W configuration. It can be used in all critical applications.



### Temperature

-200°C to 650°C, with a limit of 450°C for weakly oxidising fluids and hot air.



### Pressure range

It covers all the pressure classes up to API 10000 psi.



### pH Range

0 to 14, except for strong oxidants.

- ## Approvals
- TA LUFT VDI 2440
  - Weight Loss Test EN 14772, section 6.7



**Controller One Evolution**

**Controller 2 Evolution**

## Low Emission Design

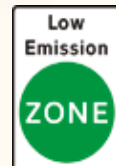

### Long-lasting low emission reliability

The CONTROLLER EVOLUTION seal set is made with GR80SGR packing and high-purity expanded graphite rings.

Both products are treated with oxidation and corrosion inhibitors, and have a very low sulphur and halogen content. The long-lasting

low emission reliability of the CONTROLLER EVOLUTION range is ensured by the high quality of the materials chosen for its production.

### Differential density

Thanks to differential density moulding technique, the W shape and the use of special GR80SGR packing, the CONTROLLER EVOLUTION sets have a low friction coefficient. This is due to the reduced seal compression when the valve is actuated, which delays the need for re-tightening during service.



## ■ GR8807

### INCOBRAID®

GR8807 INCOBRAID® is a special packing for valve applications. It has unmatched elasticity in the most demanding conditions.



#### Temperature

-100°C to 650°C, with a limit of 450°C for weakly oxidising fluids and hot air.



#### Pressure range

Up to 300 bar.



#### pH Range

0 to 14 except for strong oxidants and incompatible fluids.

## Approvals

- Specifically for HT - HP Valves
- High elasticity
- High extrusion resistance

**GR8807  
INCOBRAID®**



## GR8807 INCOBRAID®, effective and safe

GR8807 INCOBRAID® is a packing developed and manufactured by Carrara in a completely innovative way. Its PAN (polyacrylonitrile) graphite yarn is reinforced with thousands of discontinuous Inconel® filaments, which are very similar to PAN fibres in size.

### Greater elasticity

The particular intim blending reinforcement technique makes packing body extremely compact, as well as incredibly elastic and resistant. When it is installed in a stuffing box, the packing gives a greater elastic force than that of synthetic graphite, which is still greater than that of expanded graphite and of traditional reinforced yarns with a single continuous metal filament.

### Low relaxation and high extrusion resistance

The very high elastic memory of GR8807 INCOBRAID® remains the same over time, minimising the relaxation of the stem set and reducing the need for re-tightening. Its compactness also guarantees that there is no extrusion.

### Steam, hydrocarbons and chemicals

GR8807 INCOBRAID® is effective and safe in all valve applications in power stations, refineries and petrochemical plants. Its special impregnation, enriched with a passive corrosion inhibitor, protects the stems from corrosion and ensures long-term safety and reliability.

## ■ GR8800

GR8800 is the most versatile PAN graphite packing in the Carrara product range. It is suitable for all industrial valve services with graphite-compatible fluids at both medium and high pressures. However, it can also be used in many dynamic applications. Thanks to its high elastic memory, it ensures excellent performance in any application.

It is also available in the GR8800R version with metal reinforcement.

- **Versatile**
- **Effective**
- **Reliable**

### Special Design

The continuous-fibre PAN (polyacrylonitrile) graphite yarn of **GR8800** is completely unaffected by steam and most chemicals at both low and high temperatures. The dimensional stability of its fibres leave the elasticity of the packing unaltered even with thermal cycling. The fibres are enriched with a passive corrosion inhibitor to protect the stems.

T°C	①	-100/+450*/+650
P Bar	②	300
Ph	③	0 ÷ 14*

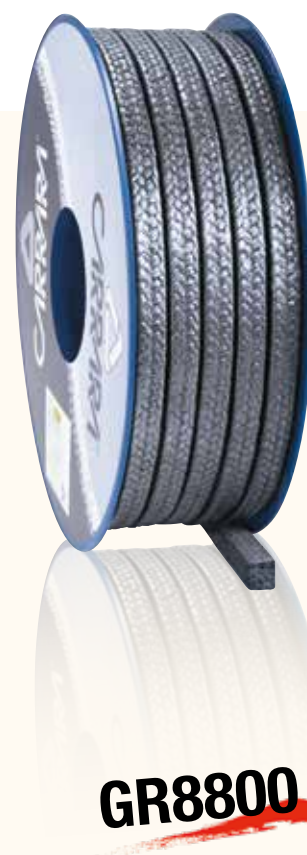

## ■ GR80SG

GR80SG is an expanded graphite packing that is indispensable for daily valve maintenance. It can be used in many dynamic contexts. It is easy to cut and install. For applications above 100 bar, GR80SG must be assisted by anti-extrusion wiper rings.

It is also available in GR48 and GR48R versions with metal reinforcement.

- **Flexible**
- **Easy to install**

### Steam, Hydrocarbons and Chemicals

**GR80SG** is made with expanded graphite yarn that is oxidation resistant and enriched with a passive corrosion inhibitor. GR80SG always gives the best results if it is used with **GR8807 Incobraid®** or **GR8800** wiper rings.

T°C	①	-200/+450*/+650
P Bar	②	300**
Ph	③	0 ÷ 14*

\* Graphite cannot be used with oxidising or incompatible fluids. With weakly oxidising fluids and hot air, the temperature must be limited to 450°C.

\*\* If used above 100 bar, expanded graphite must be protected by anti-extrusion wiper rings.



## ■ GR8OSGR OXY

### Oxygen service

GR8OSGR OXY is an expanded mineral graphite that is BAM approved for industrial oxygen service valves.

The valve is made with very pure expanded graphite yarn, enriched with an oxidation retardant. It is precisely the latter feature, together with the care with which it is made, that gives GR8OSGR OXY its exceptional resistance to contact with oxygen in both the liquid and gaseous states.

Every production batch can be tested in accordance with ASTM G136-03 to determine the amount of residual soluble compounds and ensure that the product is extremely clean.

### Approvals

- AIT higher than 500°C
- Artificial ageing: 100h at 325°C and 250 Bar
- AIT of the aged sample higher than 500°C
- Impact with Gaseous Oxygen at 300°C
- Impact with Liquid Oxygen

**BAM approved  
for services**



### Oxygen Design

The BAM tests include various types of analysis to investigate the behaviour of the material in different temperature and pressure conditions with pure oxygen. The AIT (Auto Ignition Temperature) test is performed twice. First on an untreated sample and then on an aged sample.

The ageing is performed for 100 h at 325°C and 250 Bar. Impact tests with liquid and gaseous oxygen complete the compatibility analysis. **GR8OSGR OXY** passed each test phase with flying colours, obtaining the BAM approval.

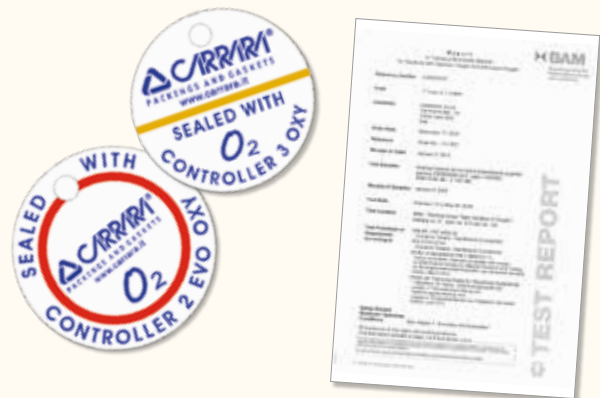

The graphite products in the OXY line that are BAM approved for industrial oxygen service valves are manufactured according to a strict procedure to prevent any contamination, ensuring that they are extremely safe and reliable.

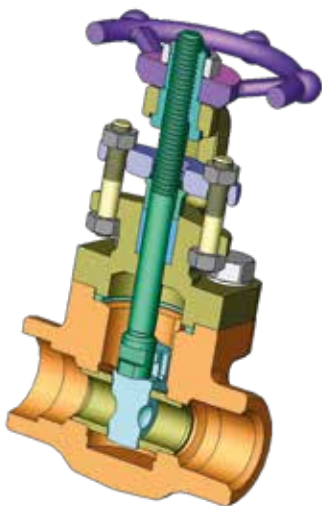

The Carrara OXY product line is specifically for use with liquid and gaseous oxygen.



#### Temperature

Can be used with liquid oxygen and gaseous oxygen up to 300°C.



#### Pressure range

Can be used up to pressures of 220 bar with oxygen at 300°C.

## BAM approved product range for oxygen services

### GR80SGR OXY

**GR80SGR OXY** is available in packs of 1.0 - 2.5 - 5.0 kg of all sections, for use in oxygen service line maintenance.

### CONTROLLER 2 EVO OXY

The **CONTROLLER 2 EVO OXY** graphite set consists of packing rings such as Top & Bottom moulded graphite rings. The moulded graphite rings are also BAM approved.

### CONTROLLER 3 OXY

The **CONTROLLER 3 OXY** graphite set consists entirely of **GR80SGR OXY** moulded packing rings.

### V48Z OXY e V48ZN OXY

Individual graphite and reinforced graphite rings such as static valve seals.

### SW316G OXY

Spiral wound seals with graphite fillers for valve bonnets and line flanges.

### SIGRAFLEX® HOCHDRUCK

Graphite seals for valve bonnets and line flanges.



# 1.0 Graphite packings - Graphite packings for Dynamic and General services



## GR8048

GR8048 is a versatile packing that is easy to install. It can seal equally in the toughest valve applications and special dynamic applications such as soot blowers.

### GR8048

#### Special Design

**GR8048** is made from PAN graphite yarn together with expanded mineral graphite yarn. **GR8048** is therefore very flexible and compact, offering greater elasticity in all services, whether they be static or dynamic. The **GR8048A** version is specifically for boiler feed pumps.

T°C	Ⓜ	-100/+450*/+650
P Bar	Ⓜ	20/300
Ph	Ⓜ	0 ÷ 14



## GR8800B

GR8800B is a PAN graphite packing with PTFE impregnation specifically for dynamic applications with extreme pH values, in which aramid packing cannot be used due to the pH, and PTFE cannot be used as it is not tough enough.

### GR8800B

#### Dynamic applications with extreme pH values

**GR8800B** is made from continuous fibre PAN graphite yarn, which is extremely tough and resistant to wear due to the impregnation with PTFE dispersion.

T°C	Ⓜ	270
P Bar	Ⓜ	20
Ph	Ⓜ	0 ÷ 14







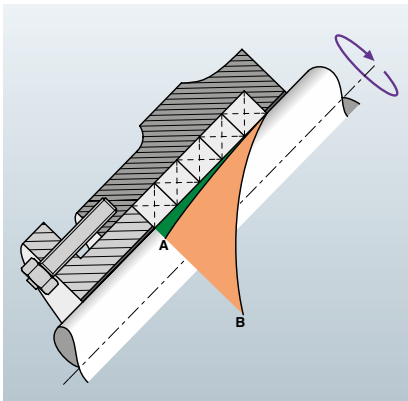

## ■ KD6605 DINACOMB

KD 6605 DINACOMB is a special packing for pumps, mixers and agitators. It is impregnated with solid lubricants and heat diffusers for better resistance and sealing. KD6605 DINACOMB is specifically for use with high-concentration abrasive fluids that are typical of applications in the mining, sugar manufacturing, oil shale, sand and gravel, urban water and sewage, and intensive farming sectors.



-  **Temperature**  
up to 250°C
-  **Pressure range**  
up to 30 bar
-  **pH Range**  
3 to 12
-  **Speed**  
20 m/s

### Approvals

- Abrasion resistant
- Cut resistant
- Impregnated with solid lubricants and heat diffusers

## KD6605 DINACOMB



### Aramid and PBI Fibres: together for better performance

**KD6605 DINACOMB** is a packing developed by combining the characteristics of discontinuous long-fibre aramid yarn and PBI yarn.

PBI is used at the edges to reduce the friction coefficient precisely where the compression load on the shaft is denser.

The core is made from long-fibre aramid to give the packing support.

A perfect match for a long-lasting seal!

### Very tough fibre

This fibre remains very tough at high temperatures and in chemically aggressive environments, which are requirements in a good packing. The discontinuous long-fibre aramid yarn is twisted to reduce the friction coefficient, ensuring a toughness equal to that of a continuous yarn and improving its retention of lubricants and heat diffusers.

### The role of lubricants and heat diffusers

Carrara's real know-how lies in choosing the best fibres and impregnating them. The use of solid lubricants and heat diffusers serves to reduce the friction coefficient and improve the heat distribution within the packing body.

**KD6605 DINACOMB** adopts this technology to ensure great performance.



## 2.0 Synthetic and PTFE packings - Pump packings



## ■ N1704 DINACOMB

N1704 DINACOMB is a special packing for the most demanding dynamic applications, which can operate at very high pressures. Resistant to cutting, abrasion and able to maintain its toughness unchanged for long periods, N1704 DINACOMB offers service performance that is 5 times better than that of aramid packing.



**Temperature**  
up to 280°C



**Pressure range**  
Piston pumps, up to 500 bar  
Centrifugal pumps, up to 30 bar



**pH Range**  
1 to 13



**Speed**  
20 m/s

### Approvals

- **Resistant to the highest pressures**
- **Resistant to cutting and abrasion**
- **5 times better than aramid fibre**

**N1704  
DINACOMB**



### High technology for use in pumps

N1704 DINACOMB is an exceptionally resistant packing that can operate at the highest pressures and with abrasive fluids. It is made with 100% heavy-duty yarn.

### Incomparable

N1704 DINACOMB offers better performance than aramid fibre.

- **Chemical resistant**  
It is chemically more stable with acids and alkalis.
- **Tough at high temperatures**  
It retains its toughness, which is 1.6 times higher than aramid, better at high temperatures and on contact with chemicals.
- **Cut resistant**  
Better resistance to cutting and abrasion by the fluid-borne particulate.
- **Lower friction coefficient**  
Its friction coefficient is lower thanks to the special thread-to-thread impregnation with solid lubricants.
- **Pressure resistant**  
It operates at the highest pressures due to its toughness.







# 2.0 Synthetic and PTFE packings - Pump packings



# ■ N1706 DINACOMB

N1706 DINACOMB is a packing made from advanced PPD aramid yarn. Of all the dynamic packings in the Carrara product range, it has the widest range of uses. As it can be used on centrifugal and piston pumps with particulate-rich fluids, N1706 DINACOMB is the most used packing in slurry pump applications.

-  **Temperature**  
up to 260°C
-  **Pressure range**  
Piston pumps, up to 500 bar  
Centrifugal pumps, up to 30 bar
-  **pH Range**  
1 to 13
-  **Speed**  
15 m/s

## Approvals

- Specifically for abrasive fluids
- Made from high-toughness yarn
- Impregnated with solid lubricants

# N1706 DINACOMB



## Engineered design

N1706 DINACOMB packing is 100% made from advanced PPD aramid yarn, pulled and twisted with a special production technique. The special thread configuration retains a large amount of solid lubricants and heat diffusers to improve the thermal capacity and reduce the friction.



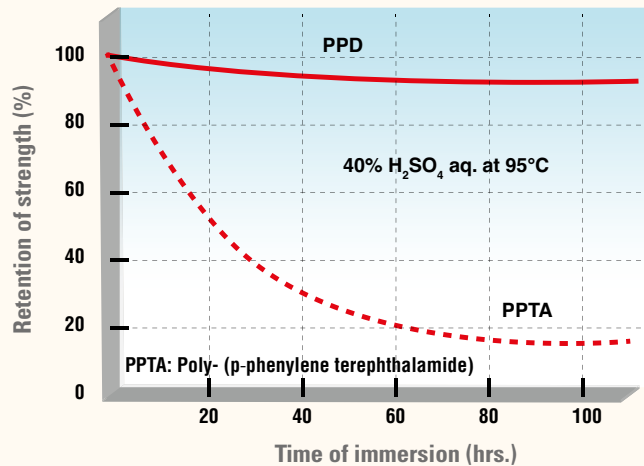

## High toughness to aid performance

The high toughness of this fibre together with the impregnation and twisting techniques mean that N1706 DINACOMB can guarantee reliability in ordinary and demanding uses.



## ■ PB5000K DINACOMB

PB 5000K DINACOMB is a specialised packing for mixer and agitator applications. It can also be used in all dynamic applications. Simple to cut and install, PB5000K packing does not wear shafts thanks to its low friction and special heat-stable impregnation.

-  **Temperature**  
up to 260°C
-  **Pressure range**  
Up to 20 bar
-  **pH Range**  
2 to 12
-  **Speed**  
15 m/s

### Approvals

- Chemical resistant
- Heat resistant
- Low friction coefficient

**NEW PB5000K  
DINACOMB**



### Unique Design

**PB5000K DINACOMB** is made from discontinuous PBI and aramid yarn with a special impregnation to further reduce its already low friction coefficient. The special controlled-pitch braiding makes the packing extremely compact and highly flexible, making installation easy.

### The impregnating technique

The special thread-by-thread impregnating technique, done with specialised modern equipment, impregnates the material homogeneously and uniformly. The latest generation of heat-resistant and highly lubricating impregnants mean that the packing can work for long periods without the need to adjust the gland follower.

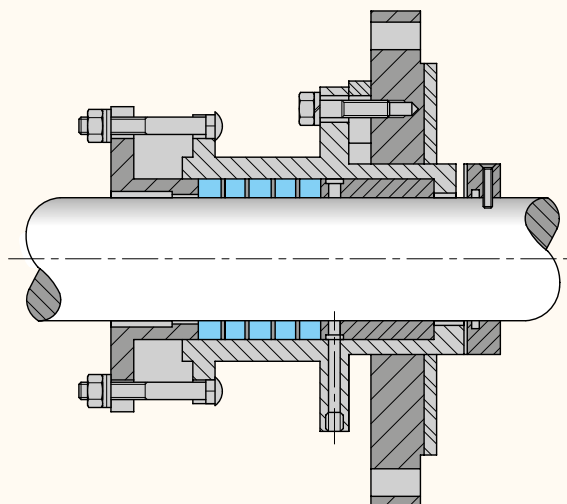

## ■ K6600C

K6600C is a silicone-free packing for extremely demanding applications that require yarns that are highly resistant to abrasion and cutting.

**K6600C** is made from very tough continuous para-aramid fibre yarns. Each thread is impregnated with a PTFE dispersion and a silicone-free lubricant.

T°C	①	-100/+280	
Ph	②	3 ÷ 12	
		Piston Pump	Centrifugal Pump
P Bar	④	100	25
V m/s	⑦	3	10



## ■ KD6604

KD6604 is the most versatile silicone-free aramid packing for dynamic sealing of industrial fluids, slurry, water and sewage.

**KD6604** is a packing made from twisted discontinuous para-aramid fibre yarn. The impregnation, which is done in three stages - on the thread, during braiding and on the product surface - increases its lubricity and resistance during service.

T°C	①	-100/+250	
Ph	②	3 ÷ 12	
		Piston Pump	Centrifugal Pump
P Bar	④	80	30
V m/s	⑦	2	20

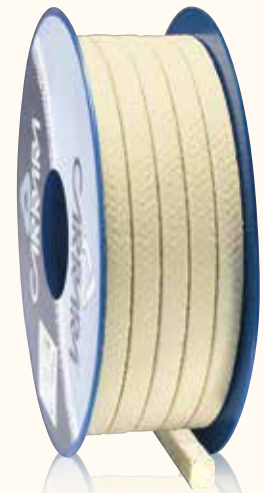

## ■ PA3604

PA3604 is an alternative silicone-free meta-aramid packing for dynamic applications. It offers high toughness with low friction for a long-lasting seal.

**PA3604** is a packing made 100% from continuous meta-aramid yarn. It is impregnated thread-by-thread with PTFE dispersion and silicone-free lubricants.

T°C	①	-100/+250	
Ph	②	3 ÷ 12	
		Piston Pump	Centrifugal Pump
P Bar	④	80	20
V m/s	⑦	2	15



# 2.0 Synthetic and PTFE packings - Pump and valve packings



## GF7700 GORE® GFO®

The GF7700 packing has the words 100% GORE® GFO® on it to guarantee its authenticity.

The special technique used to encapsulate the graphite inside the ePTFE matrix is still something that differentiates it from other types of graphite-filled PTFE.

The perfect and homogeneous graphite distribution increases its heat distribution capacity when the seal is in service.

Together with the high toughness of ePTFE, this characteristic allows GF7700 GORE® GFO® to maintain excellent levels of performance.

 **Temperature**  
-200°C / +280°C

 **Pressure range**  
Piston pumps, up to 200 bar  
Centrifugal pumps, up to 50 bar

 **pH Range**  
0 to 14

 **Speed**  
Piston pumps, 2 m/s  
Centrifugal pumps, 25 m/s

The GF7700 100% GORE® GFO® PTFE braid for pumps gives maintenance technicians a seal for general use that is suitable for a wide range of applications and uses.

Unlike other graphite-filled PTFE packings, only those made 100% with genuine GFO® fibre made by GORE®, with its 30-year success story, can offer unequalled reliability and performance. Thanks to its service life, GF7700 is clearly top quality. GF7700 can be used to seal gland followers in high-speed pumps, mixers, agitators and generally in all rotating and reciprocating systems.

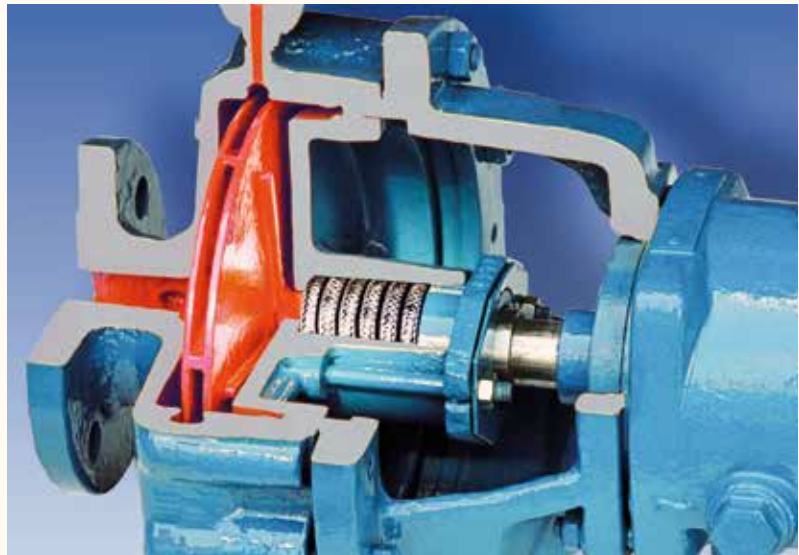

GF7700 100% GORE® GFO® does not harden nor embrittle, minimising the friction with pump shafts. Due to its excellent lubricating properties and high thermal conductivity, it can keep down the temperature of the parts in contact with the shaft, ensuring a long service life even at the highest speeds.

Easy to install and remove, GF7700 100% GORE® GFO® can be used in a wide range of temperatures and with any industrial fluids except for strong oxidants.



## ■ GF4770

GF4770 is a packing made from ePTFE with encapsulated graphite specifically for valves and piston pumps. It offers great resistance to extrusion and wear.

### GF4770

**GF4770** is made from pure GORE® G4 yarn composed of ePTFE fibres with encapsulated graphite without any added lubricant. Since it can be used with any fluid except for oxidants, **GF4770** is a product that offers a high level of guarantee and safety in service.

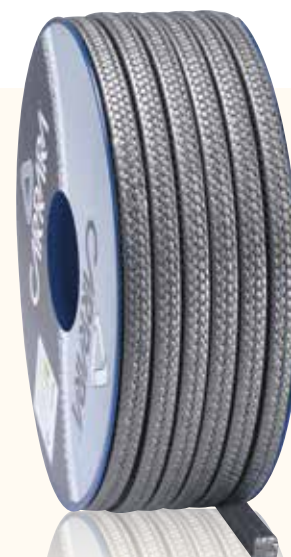

T°C	①	-200/+280		
Ph	②	0 ÷ 14		
		Valve	Piston Pump	Centrifugal Pump
P Bar	③	500	200	80
V m/s	④	1	2	10

## ■ GF7600K

GF7600K is the most used packing in dynamic reciprocating and centrifugal applications with all industrial fluids and slurries with a compatible pH.

### GF7600K

**GF7600K** is made from GORE® GFO® yarn with aramid yarn on the edges to toughen the parts of the packing that are most subject to stress and mechanical wear.



T°C	①	-100 / +250	
Ph	②	3 ÷ 12	
		Piston Pump	Centrifugal Pump
P Bar	③	250	50
V m/s	④	3	25

## PT5500 OX

PT5500OX is a pure PTFE packing that is BAM certified for oxygen service.

**BAM approved**

**PT5500OX** is specifically for gaseous oxygen service sealing in industrial valves. BAM cert. 15019234 E.

		Oxygen Service Valve
T°C	①	60
P Bar	②	30



## PT5504S

PT5504S is a PTFE packing for all applications that require high chemical resistance.

**PT5504S** is a packing made from twisted pure multi-fibre PTFE yarn. It has very high chemical inertia and is compatible with foodstuffs. It is available in the PT5504L version with silicone-free lubricants for dynamic applications as well as the PT5504AL FDA version.

T°C	①	-200 / +280	
Ph	②	0 ÷ 14	
		Valve	Piston Pump
P Bar	③	500	150
V m/s	④	1	2



## PT5600K

PT5600K is a PTFE- aramid packing for those dynamic applications that require greater toughness and resistance.

**PT5600K** is a packing made with a pure PTFE yarn core and aramid yarn on the edges to increase its resistance in high-pressure dynamic applications.

T°C	①	-200/+280		
Ph	②	3 ÷ 12		
		Valve	Piston Pump	Centrifugal Pump
P Bar	③	500	300	25
V m/s	④	1.5	2	10







## Packings for special applications



## GF4600KS

GF4600KS is a packing made from Gore® G4 with high-toughness aramid yarn at the edges for reciprocating and high-pressure dynamic applications. GF4600KS can be used with all industrial fluids with a pH in the range from 3 to 12. It ensures high performance and long service cycles, increasing profitability due to the increased process yield while reducing the need for gland follower adjustments.

-  **Temperature**  
up to 250°C
-  **Pressure range**  
up to 500 bar
-  **pH Range**  
3 to 12
-  **Speed**  
3 m/s

### Approvals

- Innovative combination of two yarns
- Special construction technique
- Contains the latest generation heat diffusers

## NEW GF4600KS Piston Pumps



### Special Design and Production

The GF4600K packing has been specially engineered for piston pumps with the aim of giving the seal a long life cycle and increasing its reliability. GF4600K has an ultra-dense body, achieved with a special braiding, combined with exceptional flexibility that makes it easy to install.

### Resistant over time

In reciprocating motion, the packing body is stressed greatly because the fibres are rapidly stressed in two opposing directions. Its very low friction coefficient and its high heat dissipation capacity, together with the toughness of the fibres used, make GF4600KS the most resistant packing in the Carrara range for this application class.

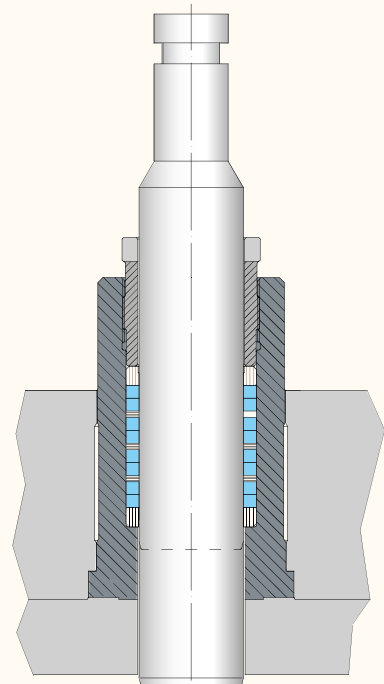

## ■ KD6604A PACKING AND TAPE FOR GLASS HARDENING MACHINES

KD6604A is fabricated with a special technique that can guarantee the tape has the required homogeneous thickness when it is wound onto the roller. The high resistance of the aramid yarn means that the tape can withstand thermal shocks for numerous tempering cycles, ensuring an excellent trade off between costs and benefits.

Available with the following sections:

Square

Rectangular

Tubular

- Resistant to wear and thermal cycling

### KD6604A



**KD6604A TAPE** is a tape specifically for rollers in sheet glass tempering furnaces. Made from high-toughness aramid yarn using the latest generation equipment to ensure extreme dimensional uniformity, **KD6604A** offers great reliability for long-term performance.



## TANK LID

The **TANK LID** range of seals for tank lids in maritime, railway and road transport of industrial fluids and foodstuffs complies with the increasingly stringent international standards.



### Temperature

50 / 120°C  
(260°C for PT5504S TANK LID)



### Pressure range

1 to 2 bar

## TANK LID

The **Tank Lid** range of seals offers a wide choice of products suited to any type of transport and any type of fluid.

- PT5504SGS SOFT TANK LID
  - A packing composed of a PTFE braid with a polypropylene body and rubber core
- PT5504SG TANK LID
  - A pure PTFE packing with a rubber core
- PT5504S TANK LID
  - A pure PTFE packing
- N3404SS TANK LID
  - A synthetic fibre packing impregnated with PTFE dispersion



# 3.0 Packings for special applications



## 9001 PAD

The 9001 PAD range is specifically for drawing machines. It ensures excellent pickling and a long service life.



**PAD APPROVED**



**K9001/2** is made from pure aramid yarn on the outside and inorganic yarn in the core. Double PTFE impregnation makes the Pad very compact.



**N9001** is made from a composite yarn that is very wear-resistant. It is impregnated with solid lubricant to reduce the friction coefficient.



**V9001** This PAD made from inorganic thread inside and glass fibre outside. It is impregnated with PTFE. This model can be used when large diameter threads are required.





# PACKINGS

PERFORMER RANGE

PREMIUM RANGE

BASIC RANGE



**B1204**  
DINAWHITE

**B1204.** This is a packing specifically for paper mills, made from a special composite yarn with a high breaking strength and very low friction coefficient to guarantee high performance over time.

**RECOMMENDED USE**

This packing is specifically for pumps, agitators and mixers in paper mills. It is also recommended for all dynamic services related to low-temperature fluids.

	P bar	lbf/in <sup>2</sup>	Vm/S	f/pm	pH	T °C	°F
					1 ÷ 14	+100	+212
	50	750	15	3000			



**GF4770**  
G4 GORE®

**GF4770.** This is a packing made from genuine GORE® G4 yarn. Silicone-free GORE® GFO® can be used for services that do not require lubrication.

**RECOMMENDED USE**

This packing is recommended for services on valves and piston pumps. It is suitable for API 641 services. It is not suitable for use with oxidising fluids.

	P bar	lbf/in <sup>2</sup>	Vm/S	f/pm	pH	T °C	°F
	500	7500	1	200			
	200	3000	2	400	0 ÷ 14	-200/+280	-330/+540
	80	1200	10	2000			



**GF7700**  
GFO® GORE®

**GF7700.** This is a packing made from genuine GFO®GORE® yarn. The words 100% GFO® are printed on the packing to guarantee the authenticity of the product.

**RECOMMENDED USE**

This packing is recommended for all dynamic applications that require resistance and flexibility at the same time. It is not suitable for use with strong oxidants.

	P bar	lbf/in <sup>2</sup>	Vm/S	f/pm	pH	T °C	°F
	300	4500	1,5	300			
	200	3000	2	400	0 ÷ 14	-200/+280	-330/+540
	50	750	25	5000			



**GR80SGR**  
EVO

**GR80SGR.** This is a packing made from pure mineral graphite with a special metal reinforcement. This packing is TA LUFT VDI2440 certified and is impregnated with a special graphite compound enriched with an inorganic corrosion inhibitor.

**RECOMMENDED USE**

This packing is for industrial valve applications in high-pressure and high-temperature services in power stations, refineries and petrochemical plants.

	P bar	lbf/in <sup>2</sup>	Vm/S	f/pm	pH	T °C	°F
	500	7500	1	200			
	100	1500	1,5	300	0 ÷ 14	-100/+600	-150/+1100

\*With weak oxidants and hot air \*\* With steam  
\*\*\* Not compatible with oxidants



**GR80SG**  
FLEXIBLE GRAPHITE HP

**GR80SG.** This is a packing made from expanded pure mineral graphite. It is impregnated with a special graphite compound enriched with an inorganic corrosion inhibitor.

**RECOMMENDED USE**

This packing can be used in industrial valve applications. For services above 100 bar and high temperatures, GR80SG must be used for Middling Rings together with the GR80SGR or GR8622.reinforced Top & Bottom Rings.

	P bar	lbf/in <sup>2</sup>	Vm/S	f/pm	pH	T °C	°F
	300	4500	1	200			
	20	300	2	400	0 ÷ 14	-200/+450*	-330/+840*
	40	600	25	5000		-200/+650**	-330/+1200**

\*With weak oxidants and hot air \*\* With steam  
\*\*\* Not compatible with oxidants  
⚠ Can only be used above 100 bar if assisted by anti-extrusion rings.



**GR8622**  
API 622 APPROVED

**GR8622.** This is a packing made from very pure expanded mineral graphite with special reinforcement. It is impregnated with a corrosion inhibitor and solid lubricants and is API 622 and EN14772 Section 6.7 low-emission approved.

**RECOMMENDED USE**

GR8622 packing is specifically for low-emission service valves in refineries, petrochemical plants and gas plants. GR8622 can be used for any valve service that is compatible with graphite.

	P bar	lbf/in <sup>2</sup>	Vm/S	f/pm	pH	T °C	°F
	500	7500	2	400			
	100	1500	1,5	300	0 ÷ 14	-200/+450*	-330/+840*
						+650**	+1200**

\*With weak oxidants and hot air \*\* With steam  
\*\*\*Not compatible with oxidants

## PACKINGS

### PERFORMER RANGE

### PREMIUM RANGE

### BASIC RANGE



**GR8807**  
INCOBRAID®

**GR8807 INCOBRAID®.** This is a special packing made from long-fibre PAN graphite reinforced with micrometric discontinuous metal filaments. The special impregnation is done in three phases: on the individual yarn, during braiding and on the packing body. The mix is enriched with an inorganic corrosion inhibitor.

**RECOMMENDED USE**

This packing is for industrial valves in high-pressure and high-temperature services in power stations, refineries and petrochemical plants.

	P bar	lbf/in <sup>2</sup>	Vm/S	f/pm	pH	T °C	°F
	300	4500	1	200	0 ÷ 14	-100/+450*	-150/+840*
	80	1200	1,5	300			

\*With weak oxidants and hot air \*\* With steam  
\*\*\*Not compatible with oxidants



**GR8888**  
SUPER GRAPHITE

**GR8888.** This is a packing made from very pure (C > 99%) long-fibre RAYON graphite. This packing is impregnated with a special graphite compound enriched with an inorganic corrosion inhibitor.

**RECOMMENDED USE**

This packing is for industrial valve and pump applications in high-pressure and high-temperature services in power stations, refineries and petrochemical plants.

	P bar	lbf/in <sup>2</sup>	Vm/S	f/pm	pH	T °C	°F
	200	3000	1	200	0 ÷ 14	-100/+450*	-150/+840*
	20	300	3	600			
	40	600	30	6000			

\*With weak oxidants and hot air \*\* With steam  
\*\*\* Not compatible with oxidants



**KD6605**  
DINACOMB

**KD6605.** This is a special packing made from long-fibre aramid yarn with PBI yarn at the edges. It is impregnated with PTFE and special compounds in three phases. The friction coefficient of PBI is much lower than that of aramid yarn to maintain the pump shaft and bearings intact.

**RECOMMENDED USE**

KD6605 is an innovative packing recommended for dynamic applications with the very abrasive fluids found in paper mills, sugar factories or cement factories.

	P bar	lbf/in <sup>2</sup>	Vm/S	f/pm	pH	T °C	°F
					3 ÷ 12	-100/+250	-150/+480
	80	1200	2	400			
	30	450	20	4000			



**N1704**  
SUPER HP

**N1704.** This is a special packing made from high-toughness fibre with good mechanical and thermal properties, better than those of aramid fibre. It offers better performance on piston and centrifugal pumps where high mechanical resistance is required.

**RECOMMENDED USE**

N1704 is a packing specifically for slurry pumps. It can be used in all dynamic applications with a U13 pH range.

	P bar	lbf/in <sup>2</sup>	Vm/S	f/pm	pH	T °C	°F
					1 ÷ 13	+280	+540
	500	7250	5	1000			
	30	450	20	4000			



**N1706**  
DINACOMB EVO

**N1706.** This is a packing made from new-generation technical yarn and special lubricants that guarantee excellent performance in dynamic applications with particulate-rich fluids (slurry).

**RECOMMENDED USE**

N1706 is specifically for reciprocating and centrifugal pumps, mixers, augers, dryers and refiners.

	P bar	lbf/in <sup>2</sup>	Vm/S	f/pm	pH	T °C	°F
					1 ÷ 13	+260	+500
	500	7250	3.5	700			
	25	375	15	3000			



**SQ5000**  
ePTFE WHITE GRAPHITE

**SQ5000.** This is a packing made from pure white PTFE yarn loaded with a compound to improve its heat dispersion coefficient. SQ5000 is an FDA packing.

**RECOMMENDED USE**

This packing is recommended for the pharmaceutical and food industries when there is a requirement for an FDA approved packing that is more resistant than the traditional PTFE packings.

	P bar	lbf/in <sup>2</sup>	Vm/S	f/pm	pH	T °C	°F
					0 ÷ 14	-100/+280	-148/+540
	30	450	2	400			
	20	300	15	3000			

# PACKINGS

PERFORMER RANGE

PREMIUM RANGE

BASIC RANGE



**PB5000K**  
DINACOMB

**PB5000K.** This is a packing made from discontinuous PBI and aramide yarn with a special impregnation to further reduce its already low friction coefficient.

**RECOMMENDED USE**

PB5000K is a specialised packing for mixer and agitator applications. It can also be used in all dynamic applications.

	P bar	lbf/in <sup>2</sup>	Vm/S	f/pm	pH	T °C	°F
	500	7250	3.5	700	2 ÷ 12	+260	+500
	20	300	15	3000			



**GF4600KS**  
G4 GORE® ARAMID

**GF4600KS.** This is a braid made from pure GORE® G4 yarn with aramid yarn at the edges. The G4 yarn is composed of ePTFE with encapsulated graphite. GF4600KS does not contain any lubricant and offers great resistance to extrusion and wear thanks to its ultra-dense body.

**RECOMMENDED USE**

GF4600KS is a packing specifically for high-pressure reciprocating pumps. It is suitable for all industrial fluids with a pH range from 3 to 12.

	P bar	lbf/in <sup>2</sup>	Vm/S	f/pm	pH	T °C	°F
	500	7500	3	600	3 ÷ 12	-100/+250	-150/+480
	50	750	25	5000			



**C8100**

**C8100.** This is a pure long-fibre PAN carbon packing. Each yarn is twisted and impregnated to ensure that the packing is very flexible.

**RECOMMENDED USE**

This packing is specifically for applications on boiler feed pumps and industrial pumps.

	P bar	lbf/in <sup>2</sup>	Vm/S	f/pm	pH	T °C	°F
	100	1500	1.5	300	2 ÷ 12	-60/+500	-80/+940
	40	600	25	5000			

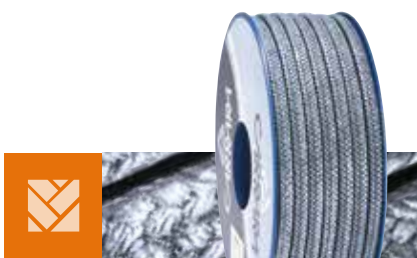

**C8104/L**

**C8104L.** This is a special packing made from multifilament PAN carbon fibre. It is impregnated with a special mixture of PTFE enriched with very pure powdered graphite.

**RECOMMENDED USE**

This packing is specifically for applications on industrial service pumps.

	P bar	lbf/in <sup>2</sup>	Vm/S	f/pm	pH	T °C	°F
	210	3150	1.5	300			
	100	1500	2	400	1 ÷ 13	-60/+280	-80/+540
	50	750	25	5000			



**C8200**

**C8200.** This is a packing made from pre-oxidised multifilament PAN. This packing is impregnated with a special graphite compound enriched with an inorganic corrosion inhibitor. It is also available in the C8300/R version with metal reinforcement.

**RECOMMENDED USE**

This packing is for general services on industrial valves and pumps (C8200 style only). It is not compatible with oxidising fluids.

	P bar	lbf/in <sup>2</sup>	Vm/S	f/pm	pH	T °C	°F
	200	3000	1	200			
	100	1500	2	600	2 ÷ 12	-50/+500*	-60/+940*
	40	600	20	6000			

\* Short exposure to peak temperature



**INCOBRAID 8207®**

**C8207 INCOBRAID®.** This is a special packing made from long-fibre PAN graphite reinforced with micrometric discontinuous metal filaments. The special impregnation is done in three phases: on the individual yarn, during braiding and on the packing body. The mix is enriched with an inorganic corrosion inhibitor.

**RECOMMENDED USE**

This packing is for industrial valves in high-pressure and high-temperature services in power stations, refineries and petrochemical plants.

	P bar	lbf/in <sup>2</sup>	Vm/S	f/pm	pH	T °C	°F
	500	7250	3.5	700	1 ÷ 13	-50/+500	-60/+940
	25	375	15	3000			

## PACKINGS

### PERFORMER RANGE

### PREMIUM RANGE

### BASIC RANGE



**GF7600/K**  
GFO® GORE® ARAMID

**GF7600K.** This is a packing made from GORE® GFO® yarn with aramid yarn at the edges to increase its mechanical resistance.

**RECOMMENDED USE**

This packing is specifically for applications on piston pumps, but it is suitable for all dynamic applications with industrial fluids except for strong oxidants. It is also available in the GL7600K and GL7676 styles with a striped design.

	P bar	lbf/in <sup>2</sup>	Vm/S	f/pm	pH	T °C	°F
	250		3		3 ÷ 12	-100/+250	-150/+480
	50		25				



**GF7676**  
GFO® GORE® ARAMID ZEBRA

**GF7676K.** This is a packing made from GORE® GFO® yarn and aramid yarn with a striped design.

**RECOMMENDED USE**

This packing is specifically for applications on piston pumps, but it is suitable for all dynamic applications with industrial fluids except for strong oxidants. It is also available in the GL7676 version.

	P bar	lbf/in <sup>2</sup>	Vm/S	f/pm	pH	T °C	°F
	250		3		3 ÷ 12	-100/+250	-150/+480
	50		25				



**GL7000**  
egPTFE

**GL7000.** This is a packing made from expanded PTFE yarn loaded with graphite and lubricated with silicone. It offers excellent reliability and performance.

**RECOMMENDED USE**

This packing is recommended for dynamic applications, It is not suitable for use with oxidising fluids.

	P bar	lbf/in <sup>2</sup>	Vm/S	f/pm	pH	T °C	°F
	200	3000	2	400	0 ÷ 14	-200/+280	-330/+540
	50	750	25	5000			



**GR8048**  
FLEXIBLE CARBON GRAPHITE

**GR8048.** This is a packing made with expanded pure mineral graphite in the core and long-fibre PAN graphite at the edges. This packing is impregnated with a special graphite compound enriched with an inorganic corrosion inhibitor.

**RECOMMENDED USE**

This packing is for industrial valve and pump applications in high-pressure and high-temperature services in power stations, refineries and petrochemical plants with non-oxidising fluids.

	P bar	lbf/in <sup>2</sup>	Vm/S	f/pm	pH	T °C	°F
	300	4500	1,5	300	0 ÷ 14	-100/+450*	-148/+450*
	40	600	25	5000		+650**	+1200**

\*With weak oxidants and hot air \*\* With steam  
\*\*\*Not compatible with oxidants



**GR8800**  
CARBON SPECIAL

**GR8800.** This is a packing made from pure long-fibre multifilament PAN graphite. It is specially impregnated in three phases with a mixture enriched with an inorganic corrosion inhibitor. It is also available in the GR8800R version reinforced with a continuous metal filament.

**RECOMMENDED USE**

This packing is for industrial valve and pump applications (GR8800 style only) in high-pressure and high-temperature services in power stations, refineries and petrochemical plants. It is not compatible with oxidising fluids.

	P bar	lbf/in <sup>2</sup>	Vm/S	f/pm	pH	T °C	°F
	300	4500	1	200	0 ÷ 14	-100/+450*	-150/+840*
	40	600	25	5000		+650**	+1200**

\*With weak oxidants and hot air \*\* With steam  
\*\*\*Not compatible with oxidants



**K6600/C**  
ARAMID SILICON FREE

**K6600.** This is a packing made from continuous aramid yarn. Each yarn is impregnated with PTFE dispersion and silicone. It is also available in the version without silicone **K6600/C**.

**RECOMMENDED USE**

This continuous aramid yarn packing is recommended for strongly abrasive dynamic applications that require the maximum resistance. It is available in the KD6604A version for the glass industry.

	P bar	lbf/in <sup>2</sup>	Vm/S	f/pm	pH	T °C	°F
	100	1500	3	600	3 ÷ 12	-100/+280	-150/+540
	50	750	15	3000			

# PACKINGS

PERFORMER RANGE

PREMIUM RANGE

BASIC RANGE



**KD6604**  
ARAMID SPECIAL

**KD6604.** This is a packing made from long-fibre aramid yarn. It is impregnated with PTFE and lubricants in three phases: on the individual yarn, during braiding and on the packing body.

**RECOMMENDED USE**

This packing is recommended for dynamic applications with abrasive fluids and on driers. It is excellent for water sampling pumps. It is also available in the KD6104 style.

	P bar	lbf/in <sup>2</sup>	Vm/S	f/pm	pH	T °C	°F
	80	1200	2	400	3 ÷ 12	-100/+250	-150/+480
	30	450	20	4000			



**N1304**  
PHENOLIC PTFE

**N1304.** This is a packing made from phenolic yarn, which has a mechanical resistance and cutting resistance similar to that of aramid yarn, but with a much lower friction coefficient. The packing is impregnated with PTFE and inert lubricants.

**RECOMMENDED USE**

N1304 is recommended for dynamic applications that require a strong packing with better chemical resistance than that offered by aramid yarn.

	P bar	lbf/in <sup>2</sup>	Vm/S	f/pm	pH	T °C	°F
	60	900	2	400	1 ÷ 13	+260	+520
	25	375	15	3000			



**N2609**  
CARBON PREOX

**N2609.** N2609 is a packing for general use at a very low price. It is made from a composite synthetic fibre with carbon at an intermediate stage of pre-oxidisation. It is impregnated with graphite and a silicone-free high-temperature lubricant.

**RECOMMENDED USE**

N2609 is a packing for general use.

	P bar	lbf/in <sup>2</sup>	Vm/S	f/pm	pH	T °C	°F
	60	900	1	200			
	40	600	3	600	4 ÷ 10	-50/+250	-60/+480
	20	300	10	2000			



**N3404**  
SYNTHETIC

**N3404.** This packing is made from synthetic yarns chosen to meet the demands of a general purpose seal. N3404 is impregnated with PTFE and inert lubricants. It is also available in the N2609 graphite-filled version.

**RECOMMENDED USE**

This packing is for general use in dynamic services. It is also available in the N3104 and N3404/SS versions specifically for manholes in tank lorries.

	P bar	lbf/in <sup>2</sup>	Vm/S	f/pm	pH	T °C	°F
	80	1200	2	400	2 ÷ 12	-100/+250	-150/+480
	50	750	15	3000			



**PA3604**  
META ARAMID PTFE

**PA3604.** This is a packing made 100% with continuous meta-aramid yarn. This meta-aramid packing has a lower friction coefficient than para-aramid, but with the same resistance to cutting and abrasion.

**RECOMMENDED USE**

PA3604 packing is specifically for dynamic applications with abrasive fluids that are compatible with meta-aramid.

	P bar	lbf/in <sup>2</sup>	Vm/S	f/pm	pH	T °C	°F
	80	1200	2	400	4 ÷ 10	-50/+250	-60/+480
	20	300	15	3000			



**PT5504/S**  
PTFE FDA

**PT5504S.** This is a packing made from pure GORE PTFE yarn. It is available in the PT5504L lubricated style, the PT5504AL type for food and pharmaceutical services and the PT55000X type for oxygen services. These products are FDA approved.

**RECOMMENDED USE**

PTFE packings have a wide range of uses in both static and dynamic applications. It is also available in PL5500S, PL5500L and PL5500AL versions.

	P bar	lbf/in <sup>2</sup>	Vm/S	f/pm	pH	T °C	°F
	500	7500	1	200			
	150	2250	2	400	0 ÷ 14	-200/+280	-330/+540

## PACKINGS

### PERFORMER RANGE

### PREMIUM RANGE

### BASIC RANGE

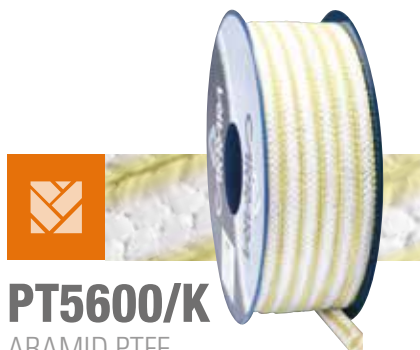

**PT5600/K**  
ARAMID PTFE

**PT5600K.** This packing is made from pure GORE PTFE yarn with aramid yarn at the edges to improve its resistance in high-pressure services and on driers.

**RECOMMENDED USE**

PT5600K is suitable for pumps in the food and chemical industries. It is recommended for driers, agitators and mixers, and it can also be used on valves.

	P bar	lbf/in <sup>2</sup>	Vm/S	f/pm	pH	T °C	°F
	500	7500	1	200	3 ÷ 12	-200/+280	-330/+540
	300	4500	3	600			
	150	2250	10	2000			



**R4804**  
RAMIE

**R4804.** This is a packing made from ramie yarn impregnated with PTFE and silicone-free lubricants.

**RECOMMENDED USE**

This packing is specifically for dynamic applications in water and industrial fluid services with medium pH values.

	P bar	lbf/in <sup>2</sup>	Vm/S	f/pm	pH	T °C	°F
	60	900	2	400	4 ÷ 10	-50/+120	-60/+240
	25	375	10	2000			

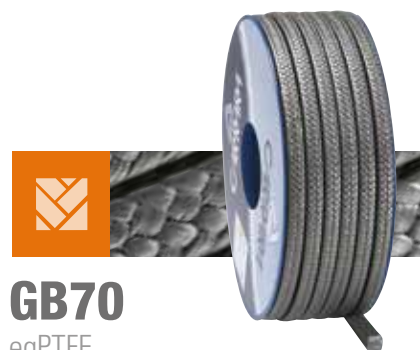

**GB70**  
egPTFE

**GB70.** GB70 packing is made from expanded PTFE yarn loaded with powdered graphite and a silicone lubricant.

**RECOMMENDED USE**

This packing is for sealing applications on pumps with any fluids, except for strong oxidants.

	P bar	lbf/in <sup>2</sup>	Vm/S	f/pm	pH	T °C	°F
	100	1500	2	400	0 ÷ 14	-200/+280	-330/+540
	25	750	20	4000			

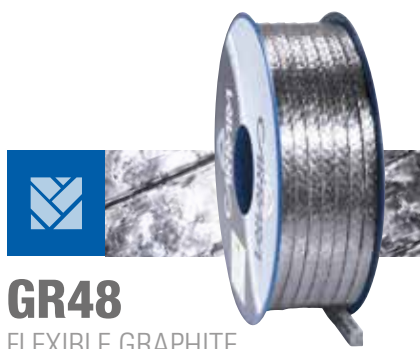

**GR48**  
FLEXIBLE GRAPHITE

**GR48.** This is a packing made from pure expanded mineral graphite. It is also available in the GR48R version with metal reinforcement.

**RECOMMENDED USE**

This packing is for applications on industrial valves and pumps with all fluids, except for oxidants.

	P bar	lbf/in <sup>2</sup>	Vm/S	f/pm	pH	T °C	°F		
	300	4500*	1	200	0 ÷ 14	-100/+450*	-150/+840*		
								+650**	+1200**

\*With weak oxidants and hot air \*\* With steam  
\*\*\* Not compatible with oxidants

Can only be used above 100 bar if assisted by anti-extrusion rings.



**GR8000**  
CARBON

**GR8000.** This is a packing made 100% with continuous PN carbon fibre impregnated with colloidal graphite. It is also available in the GR8000R version with Inconel™ reinforcement.

**RECOMMENDED USE**

This packing can be used for valve and pump services (GR8000 style only) with all high-temperature fluids, except for strong oxidants.

	P bar	lbf/in <sup>2</sup>	Vm/S	f/pm	pH	T °C	°F		
	300	4500	1	200	0 ÷ 14	-100/+450*	-150/+840*		
	20	300	2	400				+650***	+1200**
	40	600	25	5000					

\*With weak oxidants and hot air \*\* With steam  
\*\*\*Not compatible with oxidants



**KD6104**  
ARAMID PTFE

**KD6104.** This is a packing made from twisted short-fibre aramid yarn. It is impregnated in 2 stages: one on the thread, and a second one during twisting.

**RECOMMENDED USE**

This packing is for dynamic applications on pumps and agitators. It can be used in the most demanding applications where a resistant product is required.

	P bar	lbf/in <sup>2</sup>	Vm/S	f/pm	pH	T °C	°F
	80	1200	2	400	3 ÷ 12	-100/+250	-150/+480
	30	450	20	4000			

# PACKINGS

PERFORMER RANGE

PREMIUM RANGE

BASIC RANGE



**N2109**  
CARBON PREOX

**N2109.** This is a packing made from synthetic fibre. It is impregnated with graphite and a silicone-free high-temperature lubricant.

**RECOMMENDED USE**  
N2109 is a packing for general use.

	P bar	lbf/in <sup>2</sup>	Vm/S	f/pm	pH	T °C	°F
	50	750	1	200	4 ÷ 10	-50/+250	-60/+480
	20	300	2	400			
	15	225	8	1600			



**N3104**  
SYNTHETIC

**N3104.** This is a packing made from composite yarn impregnated with PTFE and a silicone-free lubricant.

**RECOMMENDED USE**  
N3104 is a packing for general applications. It is extremely versatile and of excellent quality while meeting the demand for economy and ease of use.

	P bar	lbf/in <sup>2</sup>	Vm/S	f/pm	pH	T °C	°F
	50	750	2	400	2 ÷ 12	-100/+250	-150/+480
	20	300	10	2000			



**PL5000/S**  
PTFE

**PL5000S.** The PL5000S braid is made from white ePTFE.

**RECOMMENDED USE**  
PL5000S can be used both for sealing on valve stems, or static sealing in general, and for sealing on reciprocating pumps and low-speed agitators. It is also available in the PL5000L lubricated version.

	P bar	lbf/in <sup>2</sup>	Vm/S	f/pm	pH	T °C	°F
	300	4500	1	200	0 ÷ 14	-200/+280	-330/+540
	100	1500	2	400			
	20	300	10	2000			



**V9907**  
GRAPHITIZED GLASS

**V9907.** This is a packing made from twisted glass fibre yarn (taslan) from 6 to 9 microns in size. It has a high percentage of a special graphite-based compound with the addition of a small amount of lubricant and corrosion inhibitor.

**RECOMMENDED USE**  
V9907 can be used on valve stems, manholes and where there is steam, gas, fumes, oils, acids and alkalis that are compatible with glass fibre.

	P bar	lbf/in <sup>2</sup>	Vm/S	f/pm	pH	T °C	°F
	200	3000	1.5	300	2 ÷ 12	-50/+500	-60/+940
	20	300	5	100			



**V9944**  
LUBRICATED GLASS

**V9944.** This is a packing made from slightly twisted, textured glass fibre yarn (taslan) from 6 to 9 microns in size. The braid is also impregnated with a mixture of PTFE and silicone-free inert lubricants.

**RECOMMENDED USE**  
V9944 can be used with water, steam, oils, solvents and almost any abrasive or crystallizing chemical product that is compatible with glass fibre.

	P bar	lbf/in <sup>2</sup>	Vm/S	f/pm	pH	T °C	°F
	60	900	1.5	300	2 ÷ 12	-50/+280	-60/+540
	40	600	2	400			
	20	300	15	3000			



**55B**  
EXTRUDED PTFE

**55B.** This is extruded pure unsintered PTFE with lubricants. 55B minimises shaft wear thanks to its softness. It can also be modelled in any way. Due to its high PTFE content, it is chemical resistant over the whole pH range.

**RECOMMENDED USE**  
55B is suitable for use with acids and alkalis, oils, gasses, solvents, steam and clean fluids. It can be used on centrifugal and piston pumps, mixers, agitators as well as on valves or expansion joints and vacuum pumps.

**IT IS ALSO AVAILABLE IN THE 55G GRAPHITE-FILLED VERSION.**

	P bar	lbf/in <sup>2</sup>	Vm/S	f/pm	pH	T °C	°F
					0 ÷ 14	-50/+260	-60/+510
	10	150	10	2000			

## ■ Wide range



The most innovative graphite packings in the Performer range are INCOBRAID® GR8807, the patented PAN graphite packing with discontinuous microfilament reinforcement, and GR8622. Also, for the most demanding and LOW EMISSION applications, the special GR80SGR OXY version of the GR80SGR packing is equally advanced and innovative. The PTFE packings are an important part of the packing product range. There are many versions of the PTFE packing: dry, lubricated, food grade and graphite filled. The whole range of PTFE packings, including GF7700 100% GORE® GFO®, is made using yarns from W.L. Gore, Carrara's partner for more than 25 years. Aramid yarn packings for dynamic applications, para-aramid and meta-aramid yarn packings, such as KD6605 e PA3604, and special yarn packings for abrasive applications, such as N1704 and N1706, are an important part of the range. To ensure Carrara quality, even the most well established packings, such as the V9907 and V9944 glass fibre packings, or the packings for general applications, such as N3404 e N2609, are made with the utmost care in the choice of materials and production.

**The Carrara packing range is divided into three product lines:**

**PERFORMER** The Performer line has been designed to provide customers with a high-tech packing line. It is made from the best materials, provided with full certification and is characterised by high performance and long service life.

**PREMIUM** The Premium line has been designed to provide customers with a high-tech packing line. It is made from the best materials, provided with full certification and is characterised by high performance and long service life.

**BASIC** The Basic line consists of excellent quality packings for general applications.

## ■ Packaging

Carrara packings with sizes from 3.0 to 25.00 mm are packaged in 1.0, 2.5 and 5.0 kg reels. They are packed with the utmost care to ensure a suitable storage environment for 24 months. Packings with sections greater than 25 mm in size or rectangular in shape or in customised packaging are available on request. The package weight may vary by +/- 10% with respect to the nominal value. The dimensional tolerances of the packings follow the international reference guidelines if not otherwise agreed.

Standard sections in mm	Std box kg	Std box lbs	Standard sections in inches
3 mm ÷ 5 mm	1.0	2.2	1/8" ÷ 3/16"
6 mm ÷ 12 mm	2.5	5.5	1/4" ÷ 1/2"
14 mm ÷ 25 mm	5.0	11	9/16" ÷ 1"
Over 25 mm	On request	On request	On request



For correct product use, we recommend not using any kind of lubricant or grease as it could damage the fibres and compromise the packing performance.

The length of each ring and the quality of the cut are essential for achieving the highest performance. It is always best to cut the packing with professional tools. In addition, use special extractors to remove packings from stuffing boxes.

### **Packing cutter with ruler**

Product code 006076

### **Packing cutter**

Product code 056860

### **Extractor set**

Product code 014870

### **Replacement extractor tips**

Product code 014872

## Carbon and Mineral Graphite Yarns

The Carrara Performer product range offers graphite packings made with both high-quality carbon and expanded graphite yarn, which are provided with international certifications that make them compliant with the most important standards.

Commitment, know-how and technology dedicated to sealing!

## Elasticity, mechanical resistance and chemical resistance

The various yarn options - carbon or mineral, continuous or discontinuous fibre - and the various reinforcement options and processes, affect the elasticity and mechanical characteristics of the packing. Carbon fibres give the packing high elasticity and resistance, while mineral fibres make it more flexible.

Carrara has developed a special technique of using a metal cage to reinforce expanded graphite yarn, which manages to bridge the gaps in elasticity and extrusion resistance.

Finally, the chemical and temperature resistance of carbon fibres are identical to those of expanded graphite, extended to the entire pH range from 0 to 14, with the exception of strong oxidants.

## Galvanic corrosion and activators limits

ASTM F2191 identifies galvanic corrosion activators and limits the acceptability level for class 2.

To further reduce the possibility of galvanic corrosion, Carrara widely uses passive corrosion inhibitors (ASTM F2191 Grade A), while still providing Grade B products without inhibitors.

To certify compliance with the activator limit requirements, Carrara provides certificate 3.1 for impregnated materials.

### Detrimental Materials – Graphite Packing Class 2

Element	Maximum Allowable Total Impurity Levels in parts per million (ppm)
Mercury (Hg)	10
Sulfur (S)	750
Total halogens (chlorine, bromine, and fluorine)	500
Chlorine (Cl)	250
Bromine (Br)	250
Fluorine (F)	250

## Oxidation resistance

Oxidation resistance is a further quality requirement of expanded mineral graphite for high-temperature use, as specified in the EN 14772 test. Carrara only uses graphite with an oxidation retardant to ensure that the product has exceptional resistance. In fact, the weight loss of seals due to oxidation is one of the main causes of seal defects, especially in the field of fugitive emission control.



### GRAPHITE TECHNICAL YARNS

#### ■ PAN (Polyacrylonitrile)

#### ■ RAYON

#### ■ Expanded Mineral Graphite

#### PAN

Polyacrylonitrile fibre, known as PAN or carbon fibre, is available in continuous form (each individual fibre is indefinitely long and continuous - ASTM F2191 Type I) or discontinuous form (each individual fibre is a few centimetres long - ASTM F2191 Type II) and is characterised by a high carbon C content, by an exceptional elastic memory and by a higher tensile strength than steel.

#### RAYON

Rayon fibre is available in continuous form (ASTM F2191 Type I) and is also characterised by a high carbon C content and by an elastic memory that is greater than that of expanded graphite. This soft and flexible yarn gives the packing a considerable resistance, especially in dynamic applications or on valves that are subject to frequent motion.

#### EXPANDED MINERAL GRAPHITE

Unlike the previous types, which are synthetic, expanded graphite is of mineral origin (ASTM F2191 Type III). This product is obtained by lamination, without the addition of flake binders derived from the thermal expansion of the graphite grain. The yarn, which may be reinforced with a single metal wire or a special cage, is obtained by specially processing the graphite laminate. Packings made with this material are extremely flexible and easy to use and, depending on the model, can be used in industrial valves of all pressure classes.



**Impregnation** A treatment applied to the braid with the main purpose of filling the area between the fibres, preventing fluids from passing through the braid body, improving its sealing ability and also adducting the inhibitors.

**Graphite yarn** A yarn composed of carbonised polyacrylonitrile (PAN) fibres with a high carbon content .

**Expanded graphite yarn** A yarn composed of strands of expanded mineral graphite tape.

**Impregnation** A treatment applied to the braid with the main purpose of filling the area between the fibres, preventing fluids from passing through the braid body, improving its sealing ability.

**Galvanic corrosion** An electrochemical reaction that can occur between a metal and another material (metal, carbon or graphite). When both materials are immersed in an electrically conductive context, called the electrolyte, it creates a galvanic cell and current flows between the two materials, creating corrosion.

**Corrosion inhibitor** Is an ingredient added to the packing to reduce or eliminate galvanic corrosion in the stuffing box. Corrosion inhibitors are classified as either passive or active.

**Passive corrosion inhibitor** A type of galvanic corrosion inhibitor (barium molybdate) that acts as a protective coating to block electron transfer and prevent a galvanic reaction.

**Active corrosion inhibitor** A type of galvanic corrosion inhibitor (zinc powder) that acts as a sacrificial anode, corroding in place of the surrounding metal.

**Oxidation retardant** An ingredient added to the packing to retard the graphite oxidation process at high temperatures.

**Stuffing box** The space that contains a compressed packing.

**Gland follower** The element that compresses the packing in the stuffing box.

**Bushing** A metal or carbon ring used to fill excess space in a stuffing box.

**Lantern ring** A ring added to the set of seals to aid introducing a fluid into the stuffing box. This ring is generally made of carbon or metal.

**Extrusion** The intrusion of part of the seal into the clearance between the coupled metal parts due to the pressure.

**Anti-extrusion ring** A ring of packing at one or both ends of the set of seals to prevent seal extrusion (also called “End Ring”).

**End ring** A ring used at the top or bottom of a set of seals. It works as both a wiper ring and as an anti-extrusion ring.

**EN 14772 sect 6.7 test for weight loss due to oxidation** Analysis of the hourly weight loss on a graphite sample at a temperature of 670 °C in an air-filled environment. The allowed weight loss rate is 4% per h.

**Fugitive Emissions** The loss of volatile organic compound gasses that occur at a valve stem or flange. These emissions are monitored by government agencies Usually it is expressed in parts per million by volume (ppmv or simply ppm) or in  $\text{mbar}^*1^*s^{-1}$ .

**API 622 3rd Edition** API fugitive emission test that uses CH<sub>4</sub> gas to qualify the seal.

**API 624** API fugitive emission test that uses CH<sub>4</sub> gas to qualify a rising or rotating stem valve together with the seal **API 641** API fugitive emission test that uses CH<sub>4</sub> gas to qualify a quarter turn-off valve together with the seal **ISO 15848 C01 (C02) BH** ISO fugitive emission test that uses helium gas to qualify the seal together with an ON/OFF valve **VDI 2440 TA LUFT** fugitive emission test that uses helium gas to qualify the seal together with an ON/OFF valve.

## Sealing performance Yarns, Packings and Know-how

The sealing performance of a packing for dynamic applications depends on an understanding and choice of appropriate yarns, on the choice of impregnating materials and lastly on a production process that enhances the characteristics of each component. This is the know-how of a packing manufacturer!

The Carrara Performer product range includes packings made with top-quality industrial technical yarns, which offer increasing resistance and reliability suited to every application.

## Packing performance indicators

How well does a packing perform? Much depends on the yarn and how the packing is made.

The industrial technical yarns are qualified according to their resistance to a number of factors. Among the most important are the maximum temperature of use and chemical compatibility.

At the same operating conditions [T°C; Ph; P bar; Vel m/s], yarns show different behaviours because their toughness is influenced by thermal, mechanical and chemical factors. The means that there may or may not be usage limitations and the packing performance may be more or less effective.

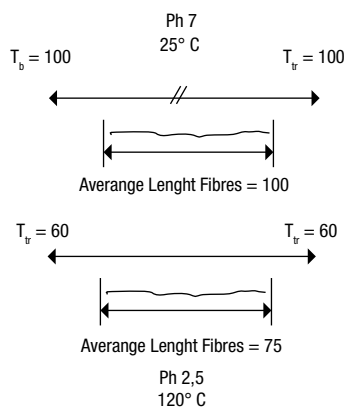

Reduction of the yarn toughness and fibre shortening due to the joint action of temperature and pH

An analysis of other indicators, mainly of a mechanical and thermodynamic nature (cutting and abrasion resistance, friction coefficient and conductivity) complete the overall picture of the intrinsic qualities of the yarns and their potential technical performance.

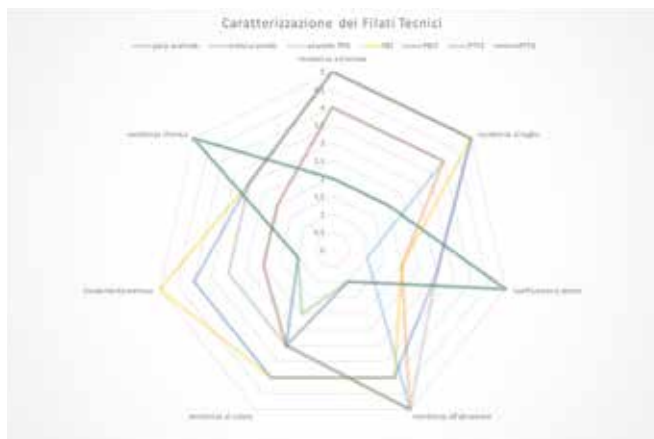

## TECHNICAL YARNS



### ■ Aramid

- Para-Aramid
- Meta-Aramid
- Advanced PPD aramid

### ■ PBI

- Polybenzimidazole

### ■ PBO

- Polybenzoxazole

### ■ PTFE

- Multifilament
- ePTFE

## Aramide

Aramid yarn, which is available in continuous and discontinuous form and in para- or meta-aramid versions, is known for its extreme mechanical resistance together with good chemical resistance. Cut resistant and abrasion resistant, the discontinuous version offers a lower friction coefficient. The advanced PPD version increases the chemical resistance and retains its toughness at higher temperatures than the para- and meta-aramid.

## PBI

This polymer-based synthetic yarn offers exceptional thermal and chemical stability with alcohols, aromatic hydrocarbons, ketones and halogenated hydrocarbons, and shows excellent toughness retention with a low friction coefficient.

## PBO

This synthetic fibre has a tensile strength 1.6 times greater than that of para-aramid, but still shows greater thermal stability and chemical resistance. Incredibly cut and abrasion resistant, it offers unequalled performance in dynamic seals.

## PTFE

The characteristics of PTFE are very well known, but less well known is its availability in continuous multi-fibre matrix yarns, which considerably increases its toughness and therefore its performance.

- ePTFE

PTFE expansion technology can achieve an extremely tough matrix and directly incorporate graphite powder or other diffusers into the material to increase its conductivity.

**Stuffing box** The space that contains a compressed packing.

**Gland follower** The element that compresses the packing in the stuffing box.

**Reciprocating Pump** A type of pump based on the reciprocating motion of a piston, or a series of piston, to create fluid pressure and flow.

**Reciprocating** Movement that alternates in the direction of the axes.

**Centrifugal Pump** A type of pump that creates fluid pressure, and therefore flow, by rotating an impeller.

**Impeller** The part of a centrifugal pump that rotates to create pressure and cause flow

**RPM** Abbreviation of “revolutions per minute”, which is the unit of shaft rotation speed.

**Shaft peripheral velocity** The tangential velocity of a pump shaft measured in m/s. Peripheral speed is related to RPM by the equation  $m/s = [(2 \times \pi \times \text{RPM} / 60) \times [\text{Shaft Diameter in metres}]] \times 0.50$

**Discharge pressure** The fluid discharge pressure measured at the pump volute outlet.

**Stuffing Box Pressure** The fluid pressure on the packing. Approximately 85-90 % of pumps have an SBP - stuffing box pressure - lower than 7 bar.

In single-stage pumps,  $SBP = [\text{Suction pressure} + 0.25 \times [\text{Discharge Pressure} - \text{Suction Pressure}]]$

In multiple-stage pumps,  $SBP = [\text{Suction pressure} + 0.10 \times [\text{Discharge Pressure} - \text{Suction Pressure}]]$

**Psi** An abbreviation of “Pounds per Square Inch”, which is the unit of pressure in the imperial system. Other pressure measurement units are Bar and MPa. These measurement units are related as follows: 1 MPa = 10 Bar; 1 Bar = 15 psi

**Lantern Ring** A ring added among the packing rings to aid introducing a fluid into the stuffing box.

**Vent Hole** A hole in the sides of the stuffing box to allow the fluid to flow in and out.

**Vent Fluid** A fluid, normally water, introduced into the stuffing box to eliminate the solid particles in the pump fluid to minimize their abrasive effects.

**Radial Expansion** The ability of the packing to expand in the radial direction within the stuffing box when it is compressed.

**Radial** In the radial direction of the pump axis.

**Cutting the packing** To prepare rings, the packing must be cut at 45 or 90 degrees. In the most demanding applications, it is best to use a packing cutter with a ruler and a 20 degree angle.

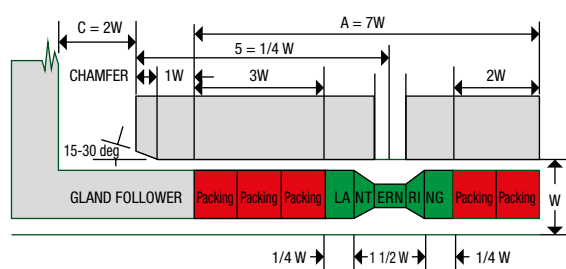

$$L = (\varnothing + s) \cdot k \cdot \pi$$

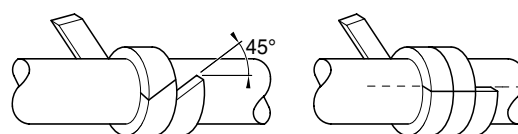

$\varnothing$ shaft diameter	K correction factor
$\varnothing < 50$	1,10
$50 < \varnothing < 100$	1,07
$\varnothing > 100$	1,03

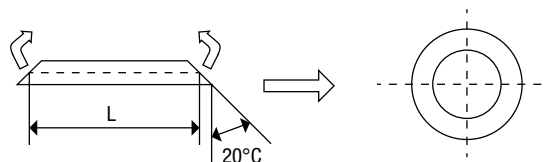

**pH** The pH scale measures the acidity or alkalinity of a fluid. In this measurement scale, 7 indicates a neutral solution (distilled water). Solutions with a pH below 7 are considered to be acids while those above are alkalis. The extreme values 0 and 14 indicate very acidic (0) or very alkaline (14) solutions.

**Slurry** This term indicates a fluid mixed with solid particulate. When the seal is composed of packing, the particulate abrades the surface of the fibres. The particulate in the slurry may be from various origins and have varying degrees of abrasiveness.

## ■ Correct installation to ensure top performance

As with all mechanical components, correct packing installation is essential to achieve the best seal performance.

It only takes a few steps to ensure that the seals operate correctly.

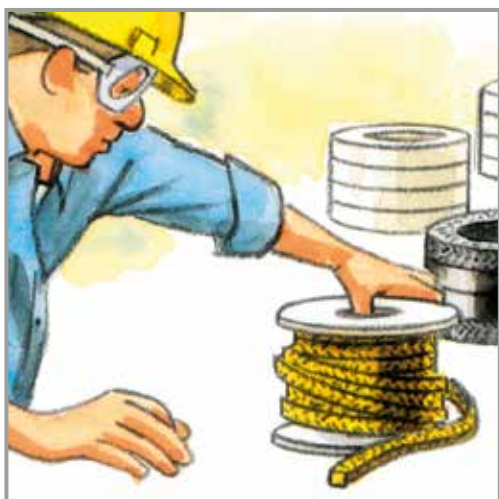

The packing size is important. Always check that the size is the right one for the specific application. Also remember that the side of the packing that must be in contact with the stem or shaft is the one that was wound on the reel.



Always cut with the utmost care. Although it is always advisable to use a tool with a ruler to accurately determine the length of the ring, the packing can also be cut with a bar of an identical diameter to that of the stem or shaft. Always cut at 45°, or straight.

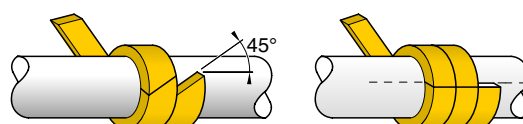

## ■ Pump maintenance

When you need to replace the packing on a centrifugal pump, be careful to remove all the worn out rings from the stuffing box. Insert the new rings one at a time, without using lubricant that could damage the packing fibres, and taking care not to align the cuts on the rings stacked in sequence.

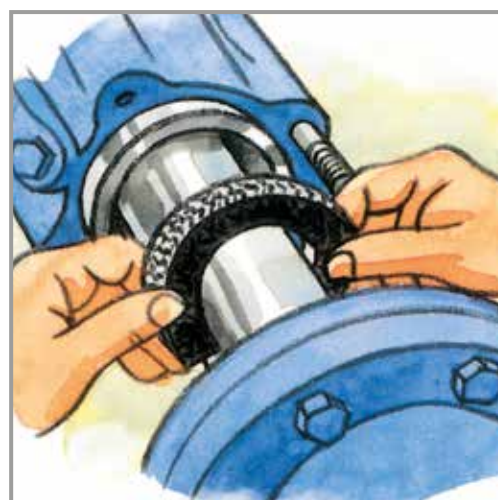

## ■ Valve maintenance

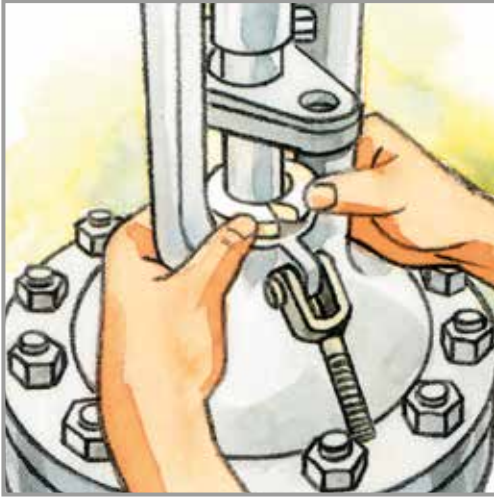

When you need to replace the packing on a valve, it is important to remove the existent packing with dedicated tools to avoid damaging the stem. Do not use lubricant or grease of any type when stacking the rings in the stuffing box. Note that the ideal number of rings is 5 or 6. If the stuffing box is deep, consider putting a bushing at the bottom of the box.



Always make sure that the gland follower is aligned with the stem guide. Tighten it as symmetrically as possible, turning each nut by one turn at a time. Tighten to the prescribed torque, operate the valve for one full cycle and then restore the initial torque.

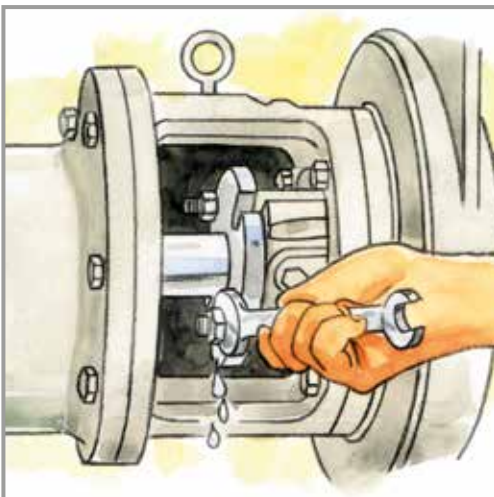

Tighten the tie rods very carefully and do not overload the seals as the pump could overheat beyond repair as soon as it is started. Adjust with the pump in motion until a few drops leak out per minute.



## CARRARA, Global Sealing Solutions!

In addition to packings, Carrara offers a wide range of high-quality gaskets for valves and flanges, together with all sealing accessories. Product quality, professional technical and sales assistance from the team, a wide stock availability and other customised services reserved for our customers are the business guidelines that increase the value that we offer our customers.



### Valve Sealants & Components Valve Sealing Systems

The complete product range of valve sealing systems includes Ball Valve Seat, Gate Valve Seat, Expanding Gate and Through Conduit Gate. Ring Joint and Spirometallic, Camprofile and Flat Gaskets for Valves, O-Rings and Lip Seals are part of the product range together with the range of products in Graphite Valvograph for Stem, Seat and Seals, certified Low Emission and Fire Safe, available in sizes from 8 mm up to 2,000 mm.



### Setting Flange Planisteel® Metal Gaskets for Flange

Spirometallic, Camprofile, Ring Joint and Metal-Plastic for equipment and boilers are part of the Carrara Planisteel® range. The STOCK LIST section of [www.carrara.it](http://www.carrara.it) allows you to check if these items are in stock in order to meet the growing demand for quick availability.



## Setting Flange Flat gaskets for Flanges

Carrara product range offers flat gasket sheets and gaskets of the following product families:

- PLANIFLEX® in CSF
- PLANIFLON® in virgin, filled, modified and expanded PTFE
- PLANIGRAPH® in graphite
- PLANIX® in rubber and Mica for high temperatures



## Setting Flange Insulating Sets

Insulating sets are used to prevent electrostatic discharge in piping. The Carrara product range offers a full range of Insulating Sets made from high performance materials suited to all pressure classes.



## Setting Mechanical Seals Tenute Mechanical Pump Seals

The Carrara product range offers a full range of mechanical seals: metal bellows single cartridge, single stationary multiple spring cartridge, single rotating multiple spring cartridge and split cartridge. Carrara mechanical seals are easy to install and ensure low component running costs.



## FERP Environmental Division

For more than fifteen years, the FERP Environmental Division of Carrara has been among the foremost international leaders in fugitive COV emissions, steam leakage, and technical and auxiliary gas leakage. It has developed Energy Saving programs and other high value-added services for the refining, energy generation, offshore and petrochemical industries.



The data given in the technical data sheets was obtained from tests carried out in the Carrara S.p.a. and third-party laboratories, and from experience in using the products in industrial applications. Selecting the product and installing it correctly are important factors in determining its operation. Carrara S.p.a. declines any liability for damage to things or persons caused by using its products improperly, incorrectly or in a non-optimal configuration. Carrara S.p.a. reserves the right to change technical data without disclosure to third parties.



[www.carrara.it](http://www.carrara.it)

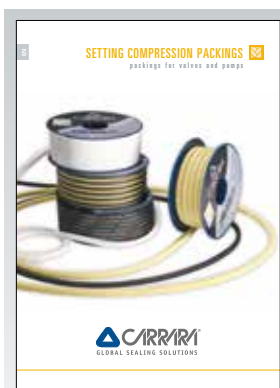

## Braided Packings

Wide range of API 622, ISO 15848, BAM and FDA qualified products for all industrial applications.



## Valve Components

Seats for soft or metal seals for ball and gate valves, seat/ball kits equipped with all the seals.



## Metallic Flange Gaskets

Planisteel is a range of spiral wound, camprofile and ring joints gaskets in accordance with the international standards or customised on demand.



## Flat Gaskets for Flange

Planigraph, Planiflon e Planiflex sheets and gaskets for all applications.

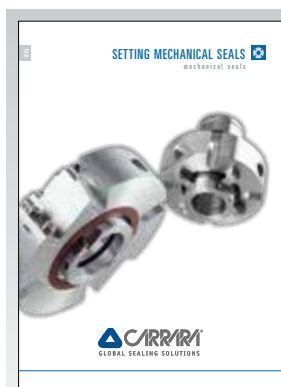

## Mechanical seals

The Single Stationary Multiple Spring Cartridge and Metal Bellows Single Cartridge mechanical seals are the main products in our range.



## Insulation Kits

Flange insulation kits for cathodic protection are one of our specialities.



## FERP Envir. Division

LDAR and SMART LDAR, tank monitoring and steam systems, 3D environmental consultancy.